

KING-METER

USERS GUIDE

NOKEE



Contents

1 Preface	1
2. Appearance and dimensions	2
2.1 Main materials and color	2
2.2 Materials and colors of buttons	3
3 Precautions for use	4
4. Overview of functions and indications	5
4.1 Overview of functions	5
5. Installation instructions	7
5.1 Installing onto handbar	7
6. Normal Operations	8
6.1 Power on/off	8
6.2 Displaying running speed	9
6.3 Setting push cruise	10
6.4 Switching headlight	11
6.5 Battery indication	12
6.6 Indication of miles	13
6.7 Error code display	14
7. Instrument Settings	15

7.1 Settings before riding	15
7.2 Setting of metric/imperial system.....	16
7.3 Maximum speed limit setting.....	17
7.4 Wheel diameter setting.....	17
7.5 Exit settings.....	18
8. FAQ	19
9. Meter Barcode	19
10. Quality assurance and scope of warranty	20
10.1 Warranty information	20
10.2 Circumstances not covered by warranty.....	20
11. Wiring Diagram.....	21
11.1 Wire sequence of standard plug connectors	21
12. Version History	22

1 Preface

Dear users,

Please read through the instructions of NOKEE meter carefully before using it to ensure a better performance of your e-bike. We will use the most concise words to show you all detailed steps for using it, including the steps from installation and setting of hardware through normal use of the instrument. The instructions will also help you eliminate the confusion and malfunctions that you may encounter.

2. Appearance and dimensions

2.1 Materials and Colour of display



NOKEE is primarily made of aluminum alloy and toughened glass. The shell of the display is made of black matte material, which can operate in the temperature ranging from -40°C to 80°C , with good mechanical properties.

The dimensions of NOKEE are shown below.
(unit: mm)

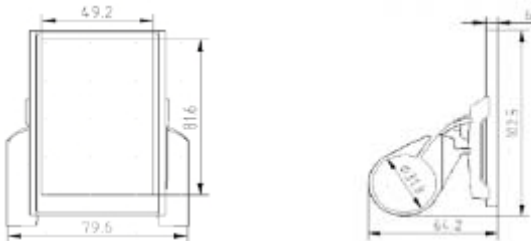

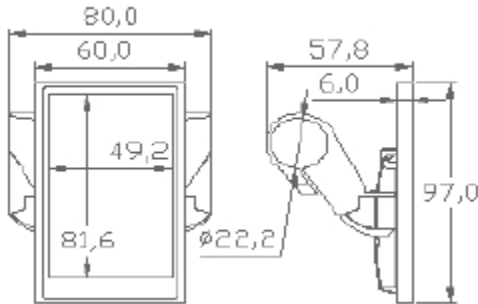

Appearance and dimensions (with 31.8mm gripper)



Appearance and dimensions (with 22.2mm gripper)

2.2 Materials and colours of buttons

The main body of the buttons is made of a PC material while the keys on them are made of soft silica gel, appearing black in general. There are three keys namely Mode , Up , and Down .

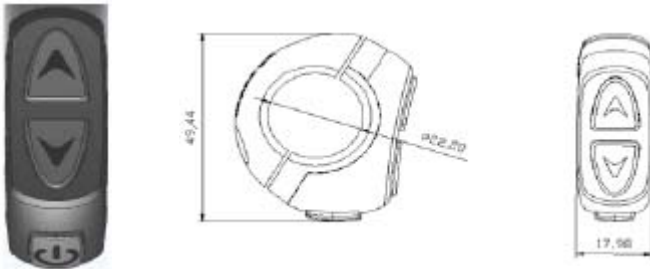

Appearance and dimensions of N3 keys(unit:mm)

3 Precautions for Use



Take care when using the meter and do not connect / disconnect it while the power is on.



Avoid bumping or striking the meter.



Avoid direct contact with water.



The parameters and settings of the meter should not be modified by the user; otherwise, the performance may be suboptimal.



The meter should be delivered for repair as soon as possible in case of malfunction.

4. Overview of Functions and Indications

4.1 Overview of functions

NOKEE provides you with a number of functions and indications to satisfy your demands while riding. The indications on NOKEE include:

- ◆ Battery indications;
- ◆ Speed indication (including real-time speed, maximum speed and average speed);
- ◆ Distance indication (including indicators for single-trip distance and total distance);
- ◆ Indication of push cruise;
- ◆ A number of settable parameters, such as wheel diameter, speed limit, setting of battery, a number of PAS levels, switching headlight, automatic shutdown, as well as burning of external program through dis-pro.

The above functions are only the existing functions of the product, which is subject to expansion according to customer's demands, such as: settings of boosting parameters, power-on password setting and controller current limit setting.



4.2 Indications



Normal display of NOKEE

5. Installation instructions

Open the gripper to clip the meter onto handlebar. Adjust it until appropriate angle of view is obtained, then screw the gripper to the recommended torque, of 1.5N.M.

5.1 Installing onto handbar



Open the gripper as per the direction of the arrow



Adjust the angle and tighten the screw.





Installation finished.

6. Normal operations



6.1 Power on/off



Press the  key for several seconds to initiate the meter and supply power to the controller. Press the  key for several seconds while the power is on to turn off the e-bike. While the power is off, the meter will no longer consume battery power and the leakage current is less than 1uA.

The meter will automatically shut down if the e-bike is idle for over 10 minutes.

6.2 Displaying running speed

Press the  key briefly to enter the speed display interface, and briefly press the  key again to display SPEED (real-time speed), AVG (average speed) and MAX (maximum speed) respectively, as shown in the figure:

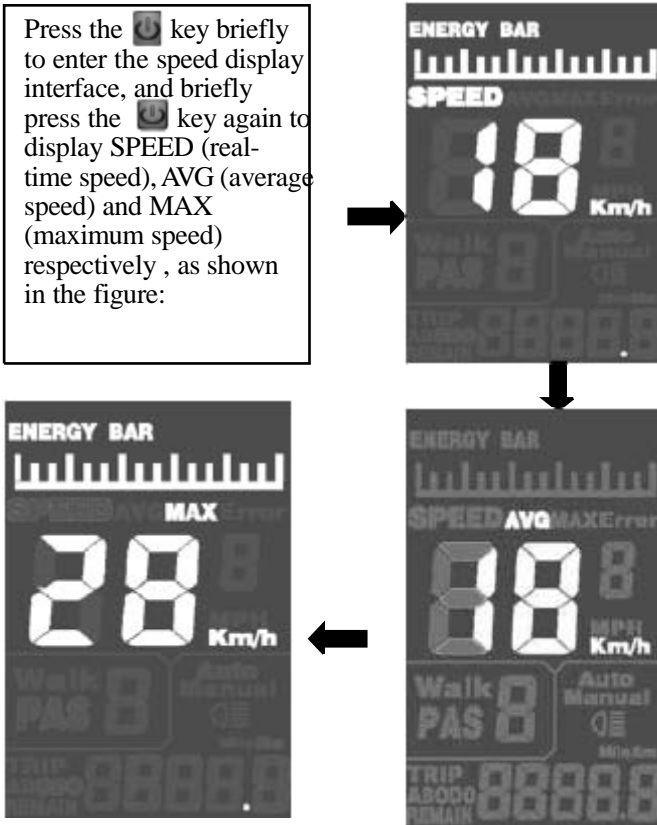

Interfaces displaying running speed

6.3 Setting push cruise



Push cruise interface



While the power of meter is on, press  for 3 seconds to enable push cruise for the e-bike, as shown in right figure. The e-bike will run at a constant speed of 6km/h. “Walk 1” is displayed on screen.



Push cruise is only for pushing the e-bike; do not use the function while you are riding the bike.

6.4 Using the headlight



Long press  to display the  symbol, as shown in the right figure, which indicates the headlight is on.

Long press  again to switch off the headlight.

Headlight switching interface



If the e-bike has no headlight function, the  symbol will not be displayed.

6.5 Battery indication

When the battery has sufficient voltage, all the six large lines will be displayed on LCD. When only one line is displayed, it indicates low battery, requiring prompt recharging.



The battery symbol as shown in the right figure indicates low battery and requires prompt recharging!

6.6 Indication of distance

Press the  key briefly to switch among indications of distance information in the following order: TRIP A (single trip distance A) → TRIP B (single trip distance B) → ODO (accumulated distance) → RMAIN (remaining distance) → TRIP A (single trip distance A). The schematic view is shown below:

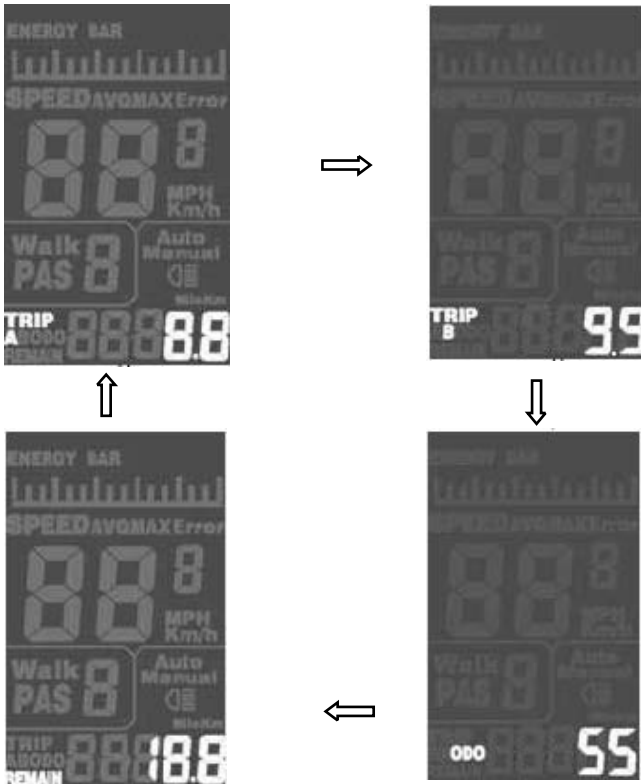

6.7 Error code display

Malfunctions in the electrical control system of the e-bike will trigger an automatic display of ERROR on the meter with the corresponding error codes. See **Attached Table 1** for definitions of detailed error codes.



Only after trouble shooting will the error code exit. It is not possible to run a defective e-bike.





Attached List 1: Definitions of error codes

Error codes	Definitions
21	Current abnormality
22	Throttle abnormality
23	Missing phase on motor
24	Motor Hall signal abnormality
25	Brake power-off sensor abnormality
30	Controller/instrument communication abnormality



7. Instrument Settings

7.1 Settings before riding

After power on, the instrument displays real-time speed by default. Press  and  for 3 seconds, to enter the setting state of unit/speed limit/wheel diameter.

Briefly press  to switch display information in the following order, ST¹ switch between metric and imperial systems (Km/h—Mi/h)→ST² speed limit setting (unit: Km/h—Mi/h)→ST³ wheel diameter setting (unit: inch)→ST¹ switch between metric and imperial systems (Km/h—Mi/h).

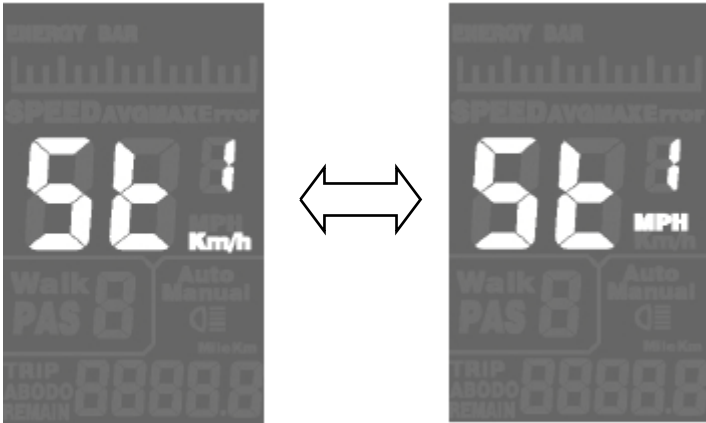

7.2 Setting of metric/imperial system

In the setting state, ST¹ stands for metric system selection. Briefly press  or  to switch between metric (Km) and imperial units (Mi). Briefly press , to confirm the setting and enter ST² setting interface.





7.3 Maximum speed limit setting



Briefly press  or  to set the Maximum limit speed, which is from 20 Km/h to 40Km/h. Briefly press  to confirm and enter the wheel diameter setting interface. The maximum limit speed of factory setting is 25Km/h.



Maximum limit speed is subject to Alteration depending on demands.

7.4 Wheel diameter setting

Briefly press  and  to Select corresponding wheel diameter, to guarantee accuracy of speed display and distance display on the meter. It can be set to: 16", 18", 20", 22", 24", 26", 28" and 700C. The factory default setting of wheel diameter is 28inches. Briefly press  to confirm and enterrunning speed display.



7.5 Exit settings

Under setting state, briefly press  (no longer than 2 seconds) to confirm and save the current setting. Press  and hold it (at least for 2 seconds) to confirm, save and exit current settings. Press  and hold it (at least for 2 seconds) to cancel the current operation and exit without saving current settings.



Setting interface will exit automatically if the meter is idle without any operation for 1min.

8. FAQ

Question: why does the meter not start up when the button is pressed?

Answer: check that the battery switch is on & check the outgoing cable for broken wires or loose connections.

Question: how do I deal with the malfunction code displayed on the meter?

Answer: Take your bike to a repair station in a timely manner.

9. Meter Barcode



513NOKEE36L0376S4001

In the number 513NOKEE36L0376S4001 below the instrument barcode, 513 refers to the customer code, NOKEE the product name, 36L the voltage of product battery, 0376 the drawing No. and S4001 the software version No..

10. Quality Assurance and Scope of Warranty

10.1 Warranty information:

- Any malfunction caused by quality defects of the product during normal use will be covered by a limited warranty by the company within warranty period.
- The warranty period is 24 months from the time the meter is delivered from the factory.

10.2 Circumstances not covered by warranty.

- Opened enclosure
- Damaged plug connector
- Scratched or damaged enclosure after delivery
- Scratched or broken lead wires of the meter
- Fault or damage due to force majeure (such as fire and earthquake) or natural disasters (such as lightning strike)
- Expired warranty

11. Wiring Diagram

11.1 Wire sequence of standard plug connectors



To controller



The end on meter



For joint

Table: wire sequence of standard plug connectors

Standard wire sequence	Color of standard wire	Function
1	Red (VCC)	Power cord
2	Blue (K)	Power supply control wire of controller
3	Black (GND)	Grounding wire
4	Green (RX)	Data receiving wire
5	Yellow (TX)	Data transmitting wire



Note: water-proof plug connectors are used for the wires of some products, so the users cannot see the colours of the enclosed wires.

2. Version History

This users guide is prepared for general-purpose software (V1.0) of Tianjin King-Meter Electronic Co., Ltd. The software version used on some bikes may vary, which will depend on the current version.

